

### Factory & HQ

Zona Industrial de Canas de Senhorim - EN 234, 3525-040 Canas de Senhorim - Portugal

+351 232 673 530 sales@staffordtowercranes.com

staffordtowercranes.com



Empresa certificada no âmbito da Conceção, Fabrico e Serviço Pós-venda de Gruas Soima e componentes

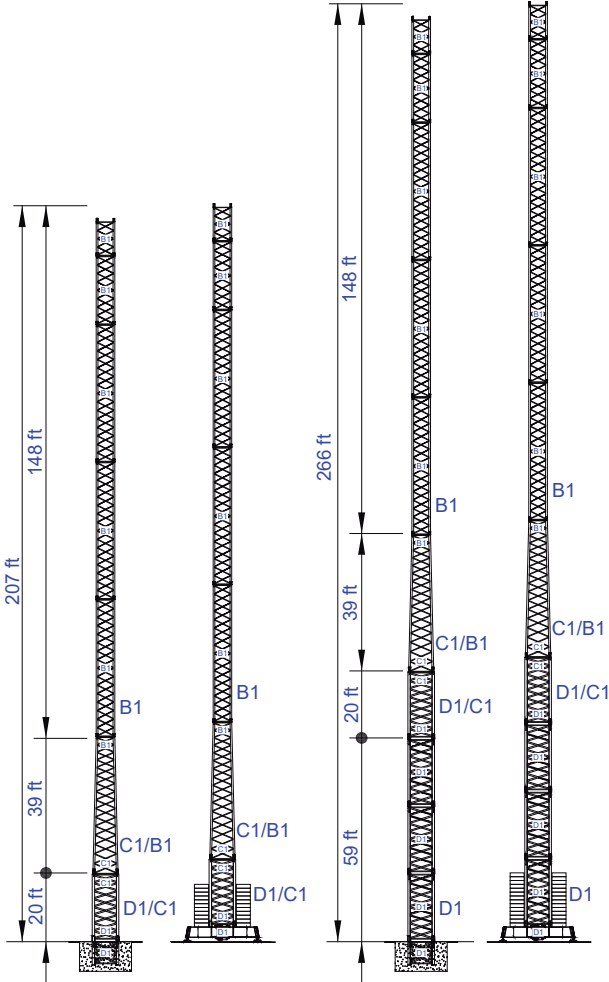
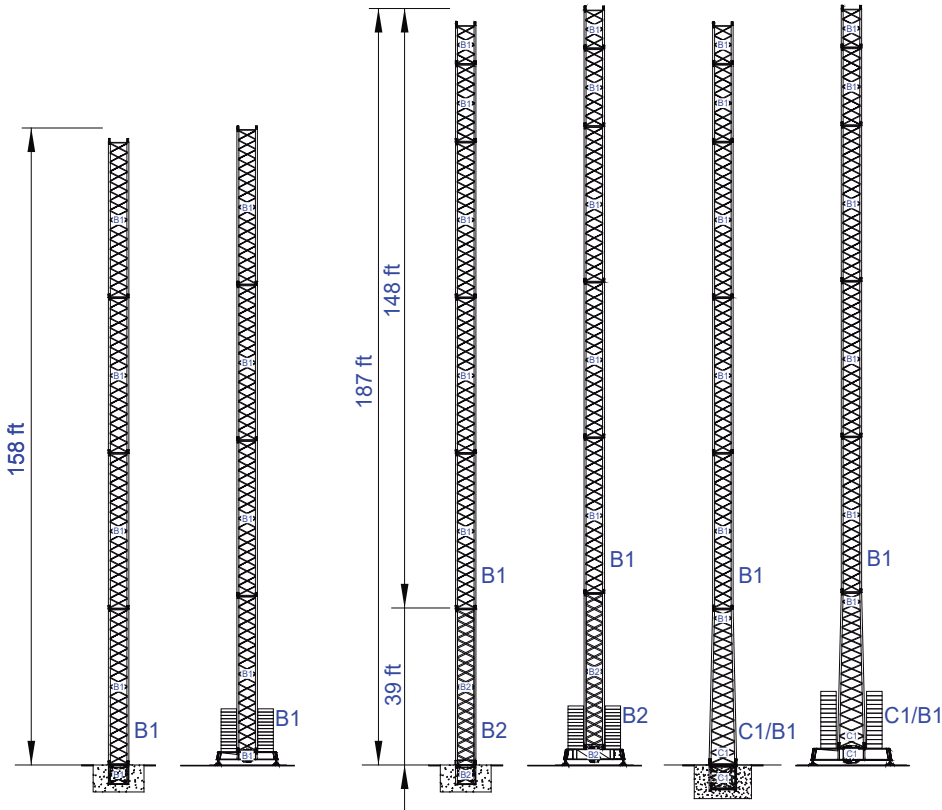

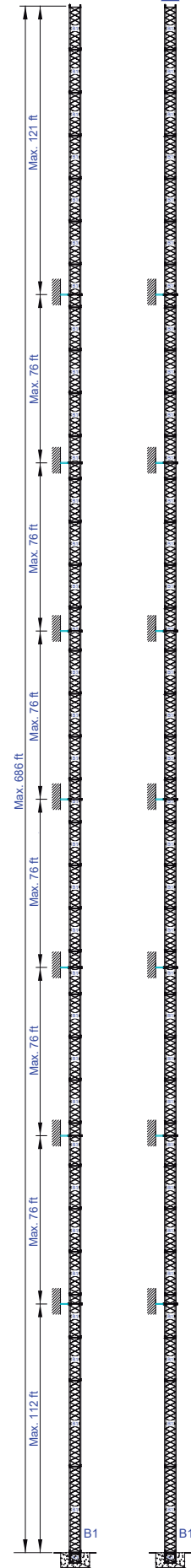
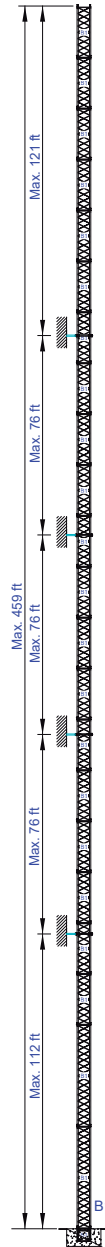
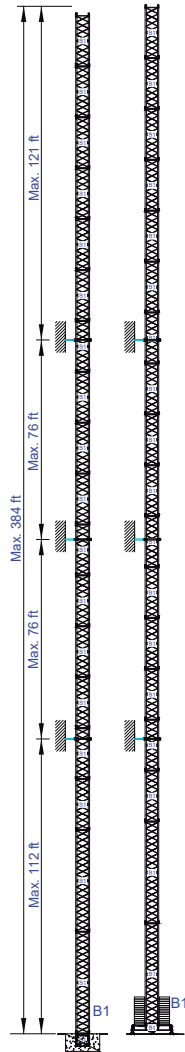
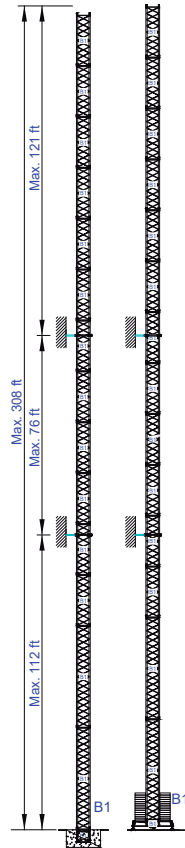
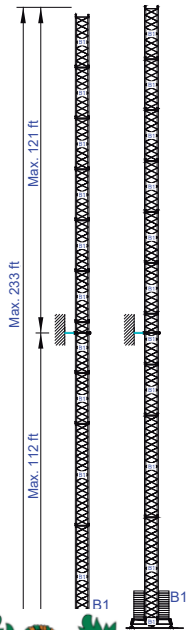
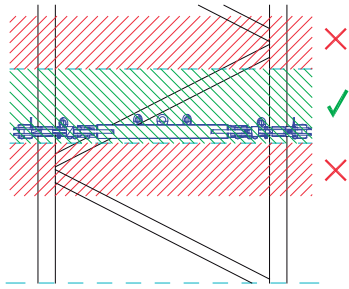
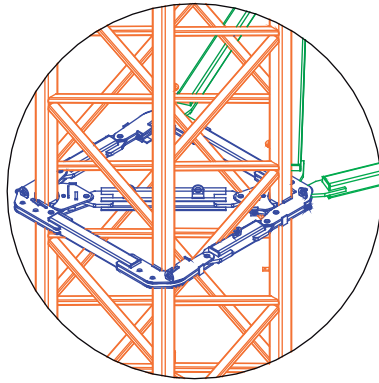

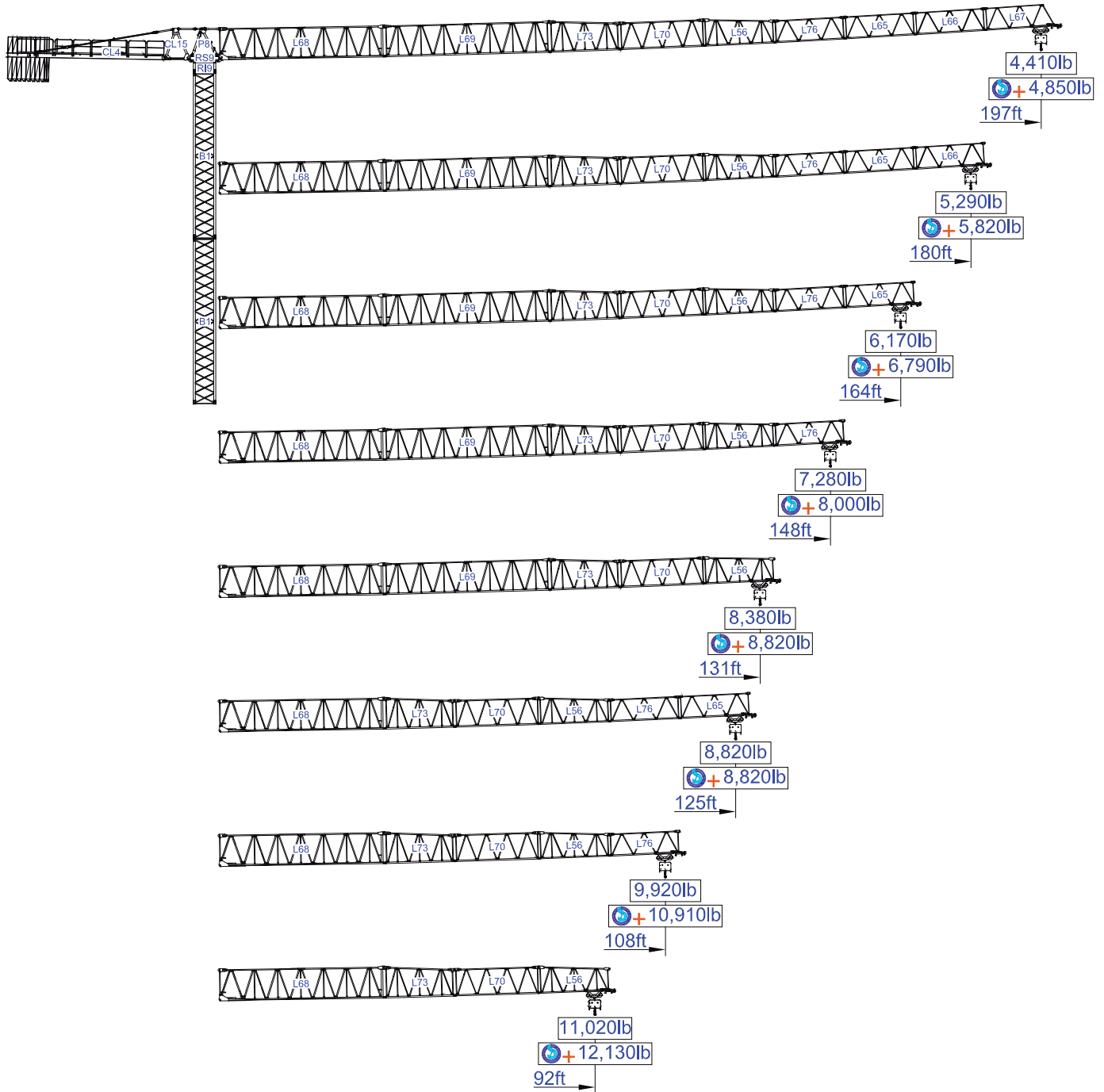













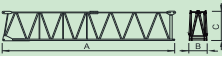

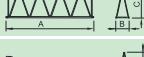
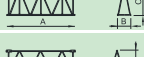

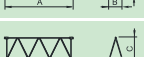
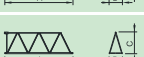

# 17,640lb

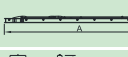
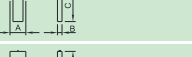
ft	Diagram	Icons		ft													ft
		17,640lb	8,820lb	32.810	49.210	59.060	75.460	91.860	108.270	124.670	131.230	147.640	164.040	180.450	196.850	lb	
197	39,690lb 8x4,4010lb + 2x2,205lb	58	109	8,820	8,820	8,820	8,820	8,820	8,820	8,820	8,380	7,890	6,860	6,060	5,400	4,850	
				17,640	17,640	17,640	14,590	11,790	9,830	8,380	7,890	6,860	6,060	5,400	4,850		
180	37,485lb 8x4,410lb + 1x2,205lb	62	116	8,820	8,820	8,820	8,820	8,820	8,820	8,820	8,470	7,360	6,530	5,820			
				17,640	17,640	17,640	15,590	12,610	10,490	8,970	8,470	7,360	6,530	5,820			
164	37,485lb 8x4,410lb + 1x2,205lb	64	120	8,820	8,820	8,820	8,820	8,820	8,820	8,820	8,800	7,690	6,790				
				17,637	17,637	17,637	16,182	13,073	10,913	9,304	8,796	7,694	6,790				
148	35,280lb 7x4,410lb + 2x2,205lb	66	125	8,820	8,820	8,820	8,820	8,820	8,820	8,820	8,820	8,000					
				17,637	17,637	17,637	16,806	13,605	11,349	9,700	9,167	8,003					
131	33,075lb 7x4,410lb + 1x2,205lb	66	125	8,820	8,820	8,820	8,820	8,820	8,820	8,820	8,820						
				17,640	17,640	17,640	16,930	13,670	11,420	9,770	9,220						
125	28,665lb 6x4,410lb + 1x2,205lb	66	125	8,820	8,820	8,820	8,820	8,820	8,820	8,820	8,820						
				17,640	17,640	17,640	16,800	13,600	11,350	9,700							
108	24,255lb 5x4,410lb + 1x2,205lb	64	120	8,820	8,820	8,820	8,820	8,820	8,820								
				17,640	17,640	17,640	16,180	13,070	10,910								
92	22,050lb 4x4,409lb + 2x2,204lb	59	112	8,820	8,820	8,820	8,820	8,820									
				17,640	17,640	17,640	15,040	12,130									

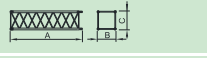
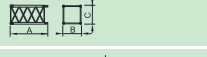

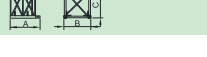

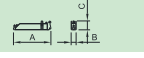
# 22,050lb

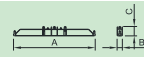
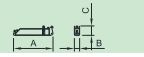

ft	Diagram	Icons		ft													ft
		22,050lb	11,020lb	32.810	49.210	59.060	75.460	91.860	108.270	124.670	131.230	147.640	164.040	180.450	196.850	lb	
197	39,690lb 8x4,4010lb + 2x2,205lb	46,9	89,5	11,020	11,020	11,020	11,020	11,020	9,700	8,250	8,000	6,790	6,060	5,340	4,850		
				22,050	22,050	18,920	14,550	11,880	9,700	8,250	8,000	6,790	6,060	5,340	4,850		
180	37,485lb 8x4,410lb + 1x2,205lb	49,8	95,1	11,020	11,020	11,020	11,020	11,020	10,430	8,970	8,490	7,280	6,550	5,820			
				22,050	22,050	20,370	15,520	12,610	10,430	8,970	8,490	7,280	6,550	5,820			
164	37,485lb 8x4,410lb + 1x2,205lb	51,6	98,4	11,020	11,020	11,020	11,020	11,020	10,910	9,220	8,730	7,760	6,790				
				22,050	22,050	21,100	16,250	13,100	10,910	9,220	8,730	7,760	6,790				
148	35,280lb 7x4,410lb + 2x2,205lb	53,4	102,0	11,020	11,020	11,020	11,020	11,020	11,400	9,700	9,220	8,000					
				22,050	22,050	21,830	16,730	13,580	11,400	9,700	9,220	8,000					
131	33,075lb 7x4,410lb + 1x2,205lb	53,7	102,6	11,020	11,020	11,020	11,020	11,020	11,400	9,700	9,220						
				22,050	22,050	22,070	16,980	13,580	11,400	9,700	9,220						
125	28,665lb 6x4,410lb + 1x2,205lb	53,4	102,0	11,020	11,020	11,020	11,020	11,020	11,400	9,700							
				22,050	22,050	21,830	16,730	13,580	11,400	9,700							
108	24,255lb 5x4,410lb + 1x2,205lb	51,6	98,4	11,020	11,020	11,020	11,020	11,020	10,910								
				22,050	22,050	21,100	16,250	13,100	10,910								
92	22,050lb 4x4,409lb + 2x2,204lb	48,1	91,9	11,020	11,020	11,020	11,020	11,020									
				22,050	22,050	19,640	15,040	12,130									





			A (ft)	B (ft)	C (ft)	lb (±5%)
Jib		L68	39.30	6.20	7.50	11,130
		L69	39.20	3.80	7.40	3,640
		L73	17.20	3.80	7.40	1,650
		L70	20.30	3.80	6.40	1,500
		L56	17.10	3.80	6.30	1,300
		L76	17.00	3.80	5.30	820
		L65	16.80	3.80	5.30	730
		L66	16.80	3.80	5.30	660
		L67	16.77	3.80	5.28	660
Head turntable		RS9 RI9	8.20	5.60	6.40	10,250
		P8	7.30	4.30	2.70	1,830
Counter-jib		CL15	6.10	4.00	7.40	1,650
		CL4	37.40	4.90	1.60	8,820
Counterweight		CP2	3.80	1.10	10.30	8x4,410 35,270
		CP3	3.80	0.50	10.30	2x2,200 4,410
Tower section / torre		B1	39.40	5.30	5.30	7,610
		B1	20.10	5.30	5.30	3,970
		B1	10.50	5.30	5.30	2,360
Climbing tower section		B1	10.50	6.00	6.00	2,430
		B1	5.80	5.20	5.20	1,430
Base Chassis		B1	21.70	1.60	3.40	4,830
			10.20	1.10	3.40	2x2,160 4,320
TOTAL						9,150
Base Chassis		B1s	18.40	1.60	3.40	3,970
			8.90	1.10	3.40	2x1,984 3,960
TOTAL						7,930

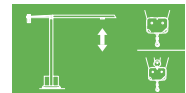

	
	0 a 1 r.p.m.      2x48 ft/lbf
	0 a 196 ft/min      5,5 kW
	0 a 32 ft/min      2x4 kW

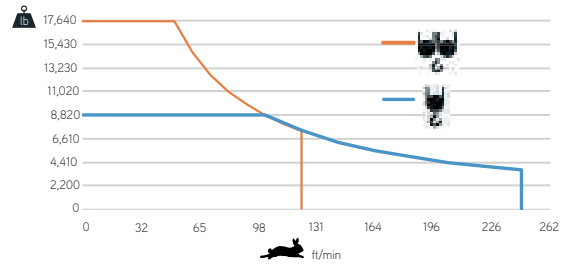
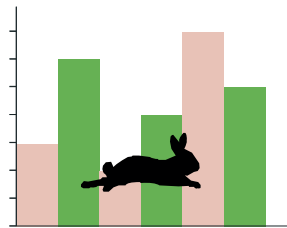
	
	0 a 246 ft/min 0 a 123 ft/min      22 kW



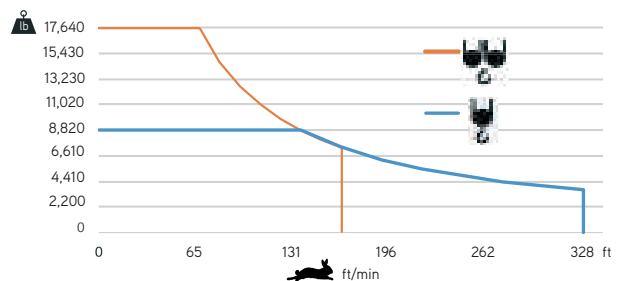

	48 kVA 400 V +- 5% (50/60 Hz)
--	----------------------------------

	
	0 a 330 ft/min 0 a 165 ft/min      30 kW



	58 kVA 400 V +- 5% (50/60 Hz)
--	----------------------------------

Max height of hoist

 (H)Max. 177ft +   
 (H)Max. 354ft



