

SACS
10%

+

Zoning

CERTIFICAÇÃO

ISO 9001

IQNET

RECOGNIZED
CERTIFICATION

Factory & HQ

Zona Industrial de Canas de Senhorim - EN 234, 3525-040 Canas de Senhorim - Portugal

+351 232 673 530 sales@staffordtowercranes.com

www.staffordtowercranes.com

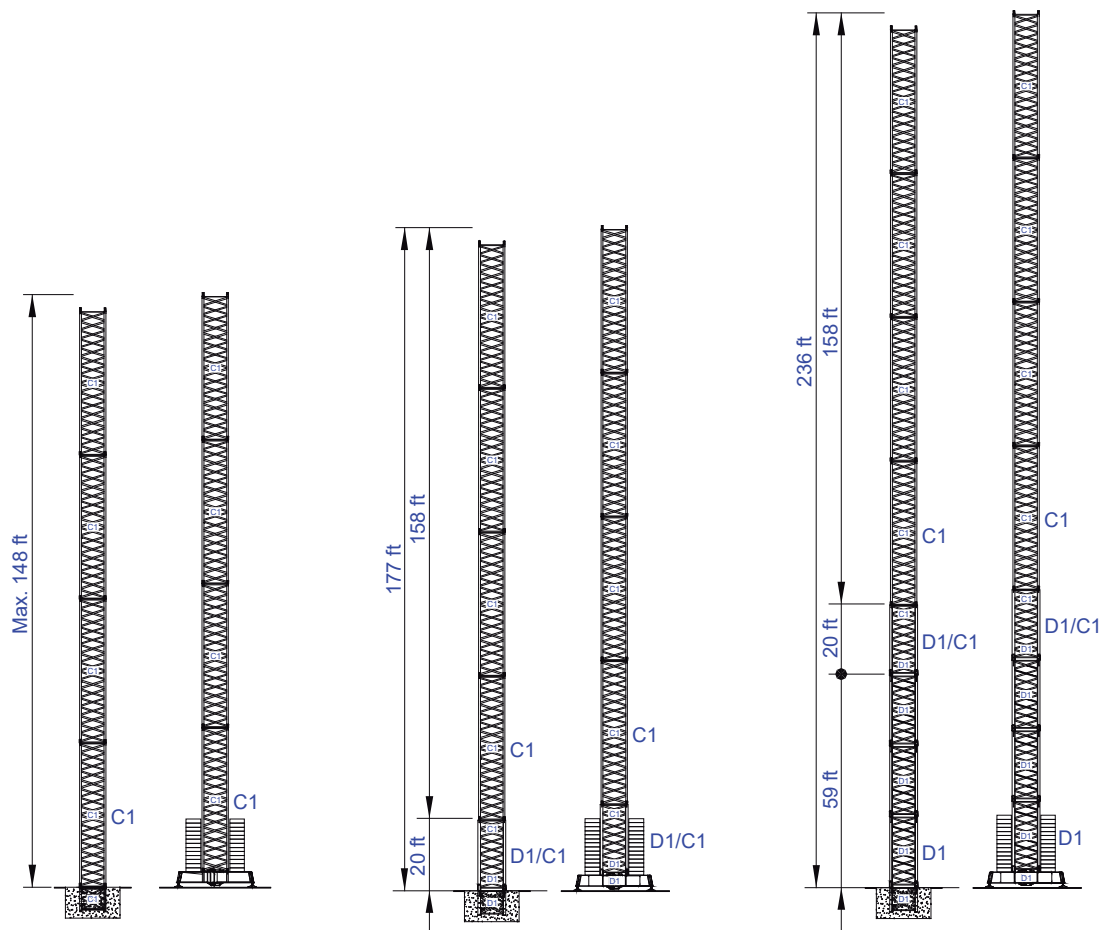

More options

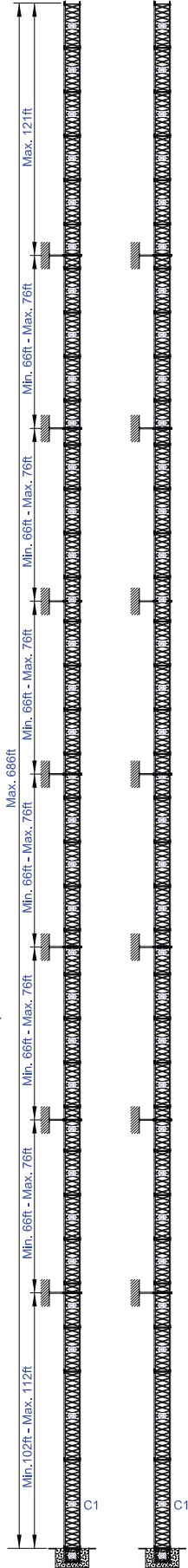
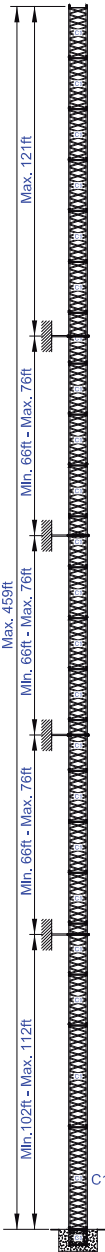
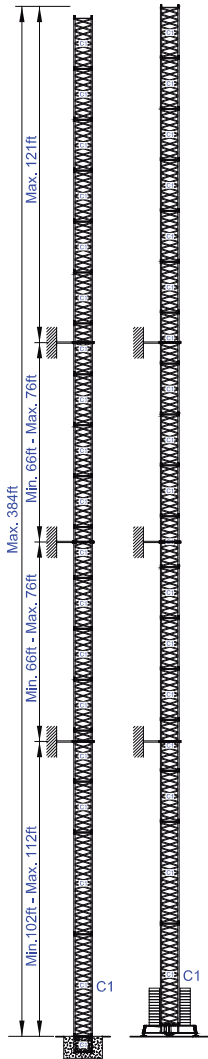
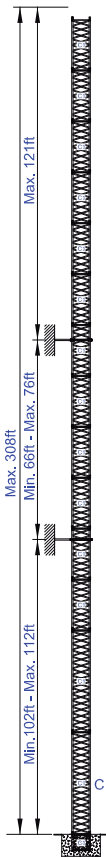
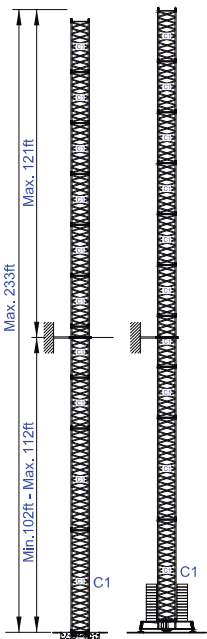
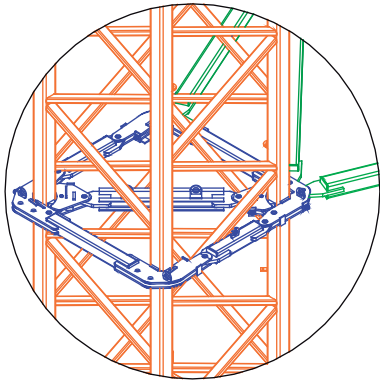
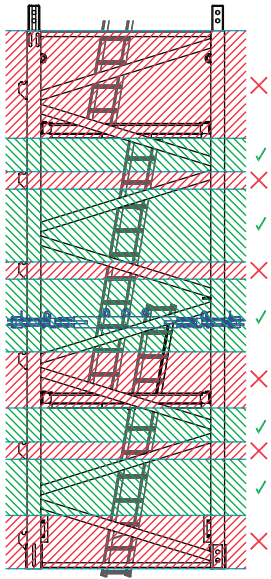

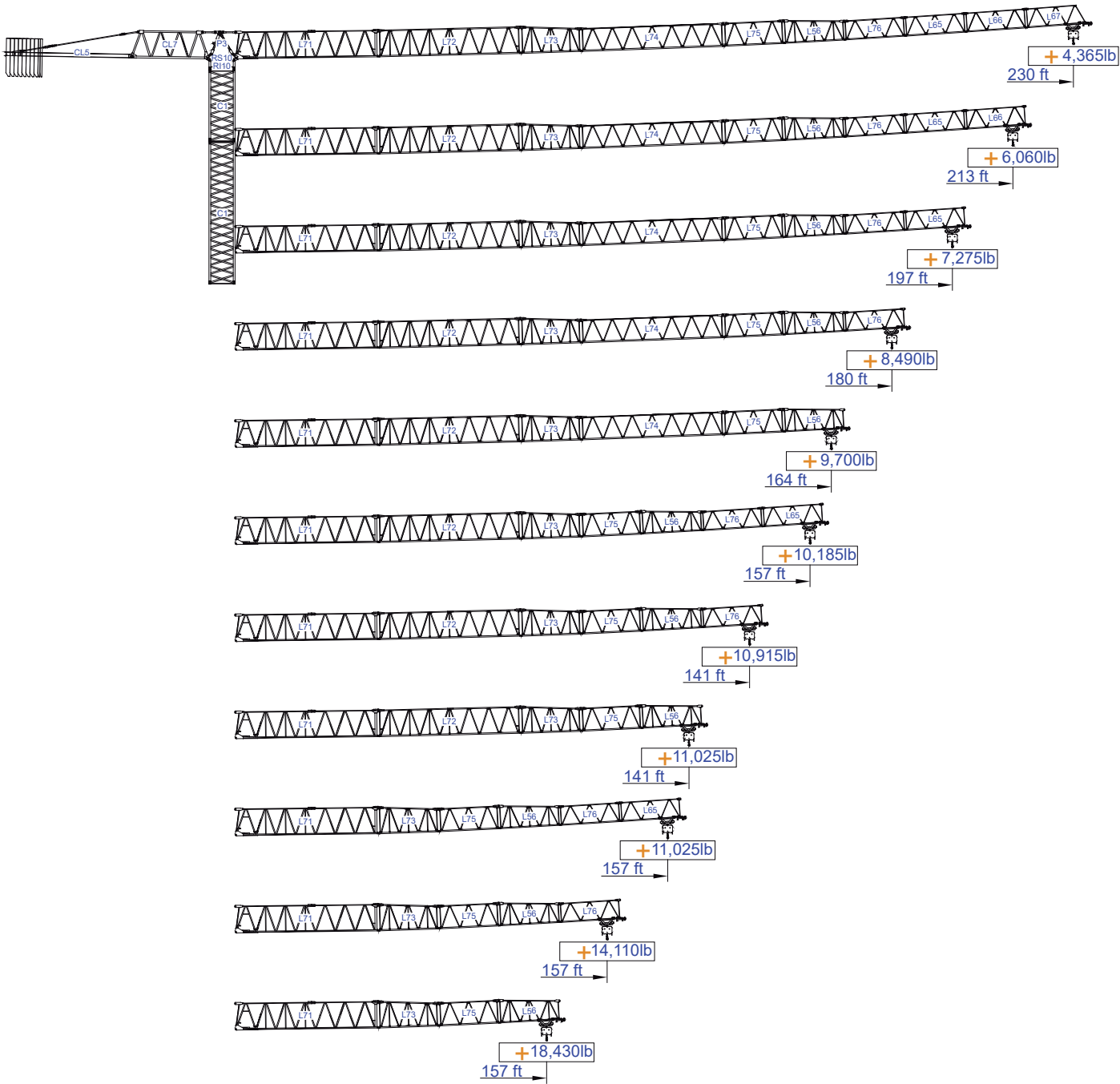

SACS 10%



ft	Diagram	Icons		ft														ft
		22,050lb	11,020lb	52	69	85	102	118	125	141	157	164	180	197	213	230		
230	39,690lb 8x4,410lb + 2x2,205lb	48.6	96.1	11,020	11,020	11,020	11,020	8,220	9,090	7,910	6,960	6,620	5,920	5,310	4,830	4,370	lb	
				22,050	16,470	12,880	10,450	8,710	8,120	6,940	5,990	5,650	4,950	4,340	3,860	3,400		
213	39,690lb 8x4,410lb + 2x2,205lb	58.7	116.5	11,020	11,020	11,020	11,020	11,020	11,020	9,820	8,680	8,270	7,420	6,690	6,060			
				22,050	20,420	16,080	13,120	11,030	10,310	0,850	5,290	7,300	6,450	5,720	5,090			
197	37,485lb 8x4,410lb + 1x2,205lb	63.3	92.5	11,020	11,020	11,020	11,020	11,020	11,020	10,670	9,430	9,020	8,080	7,280				
				22,050	22,050	17,480	14,310	12,030	11,280	9,700	8,460	8,050	7,110	63,050				
180	37,485lb 8x4,410lb + 1x2,205lb	66.3	131.2	11,020	11,020	11,020	11,020	11,020	11,020	11,020	9,940	9,510	8,490					
				22,050	22,050	18,430	15,110	12,710	11,910	10,280	8,970	8,540	7,520					
164	35,280lb 7x4,410lb + 2x2,205lb	67.7	134.2	11,020	11,020	11,020	11,020	11,020	11,020	11,020	10,190	9,700						
				22,050	22,050	18,890	15,500	13,050	12,250	10,570	9,220	8,730						
157	30,870lb 6x4,410lb + 2x2,205lb	67.9	134.5	11,020	11,020	11,020	11,020	11,020	11,020	11,020	10,190							
				22,050	22,050	19,060	15,640	13,170	12,370	10,670	9,220							
141	26,460lb 5x4,410lb + 2x2,205lb	64.6	128.0	11,020	11,020	11,020	11,020	11,020	11,020	10,910								
				22,050	22,050	18,090	14,820	12,460	11,690	9,940								
125	24,255lb 5x4,410lb + 1x2,205lb	63.0	124.7	11,020	11,020	11,020	11,020	11,020	11,020									
				22,050	22,050	17,560	14,380	12,080	11,160									
118	19,840lb 4x4,410lb + 1x2,205lb	59.7	122.4	11,020	11,020	11,020	11,020	11,020										
				22,050	22,000	17,360	14,210	11,640										
102	17,640lb 3x4,410lb + 2x2,205lb	60.7	120.1	11,020	11,020	11,020	11,020											
				22,050	21,660	17,070	13,580											
85	15,435lb 3x4,410lb + 1x2,205lb	58.7	116.5	11,020	11,020	11,020												
				22,050	20,980	16,010												
		lb		Icons														



		A (ft)	B (ft)	C (ft)	lb	Code
L71		39.27	6.23	9.51	20,940	530 70 22
L72		39.27	3.81	7.41	5,510	
L73		17.16	3.81	7.41	1,650	
L74		39.21	3.81	6.40	3,090	
L75		17.06	3.81	6.40	1,100	
L56		17.06	3.81	6.33	1,300	
L76		16.99	3.81	5.28	820	
L65		16.77	3.81	5.28	730	
L66		16.77	3.81	5.28	660	
L67		16.77	3.81	5.28	660	
RS10 RI10		8.60	7.15	7.05	17,640	
P3		7.97	4.27	2.49	2,800	
CL7		21.23	4.07	7.50	5,730	
CL5		34.62	4.92	1.64	7,830	
CP2		3.81	1.08	10.30	8x4,410 35 280	
CP3		3.81	0.54	10.30	2x2,205 4 410	704 10 00

C1		39.38	7.15	7.15	9,260	509 12 00
C1		20.11	7.15	7.15	4,850	509 06 00
C1		10.48	7.15	7.15	2,650	508 12 03
C1		10.48	7.38	7.38	3,000	509 06 03
C1		7.48	7.05	7.05	1,870	509 06 02

C1		26.67	2.63	4.50	10,140	609 00 02
		13.78	1.25	4.50	2x6,120 12,240	

TOTAL 22,380

C1s		21.67	2.63	4.50	7,540	609 00 03
		10.37	1.25	4.50	2x4,060 8,120	

TOTAL 15,660



	0 a 1 r.p.m.	3x36 ft/lbf
	0 a 196ft/min	5,5 kW
	0 a 32ft/min	2x4 kW

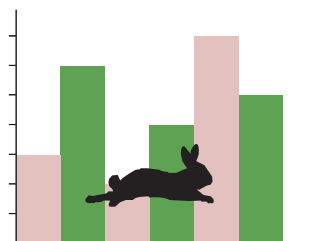

	0 a 308 ft/min	37 kW
	0 a 154 ft/min	

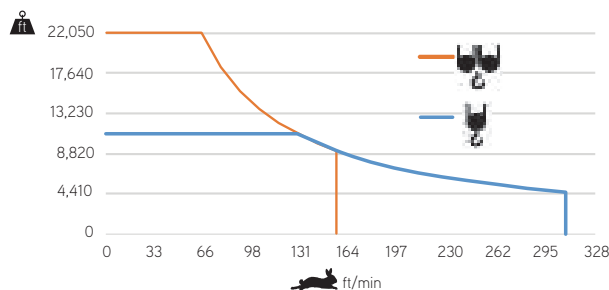

	55 kVA
	400 V +- 5% (50/60 Hz)

	0 a 387 ft/min	45 kW
	0 a 194 ft/min	

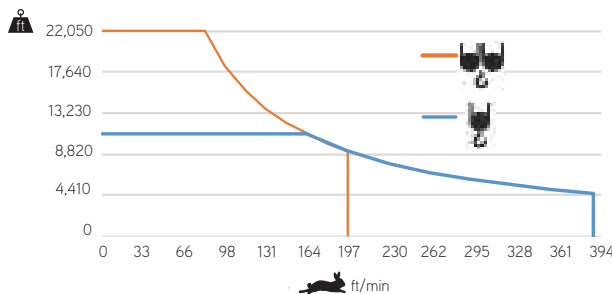

	65 kVA
	400 V +- 5% (50/60 Hz)

Max height of hoist

(H)Max. 217ft
 (H)Max. 433ft

 + More options



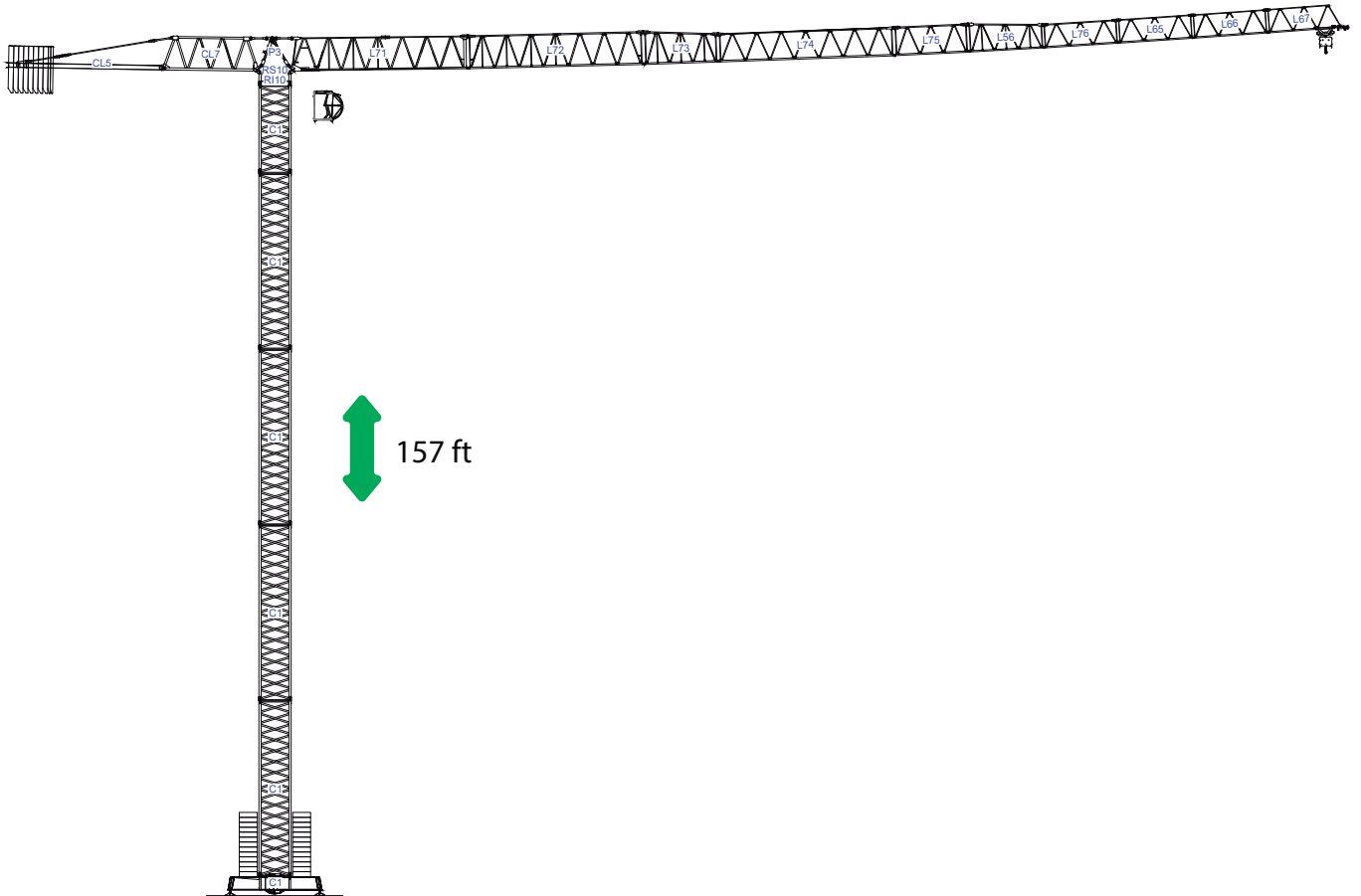

8x

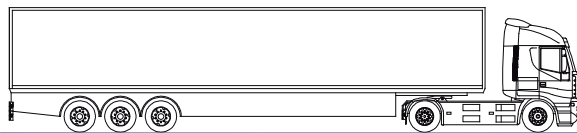

/

8x

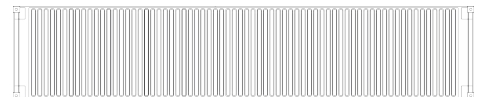

STF 7018

